

*The price quoted is the maximum retail price and is inclusive of car tax and VAT. Number plates and delivery are extra.

£4,299*

FIESTA
Bonus



£4,299
FIESTA
Bonus

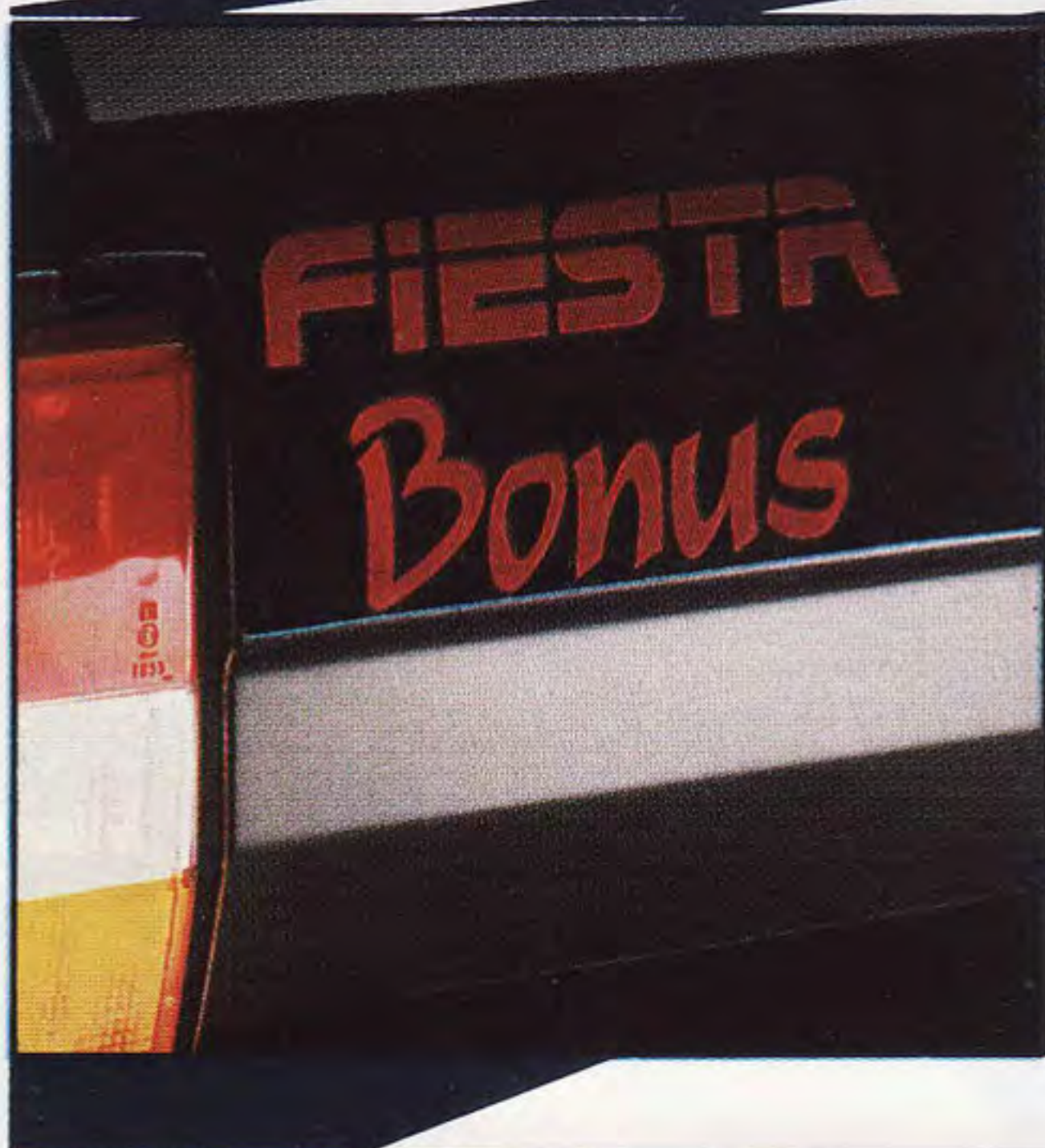
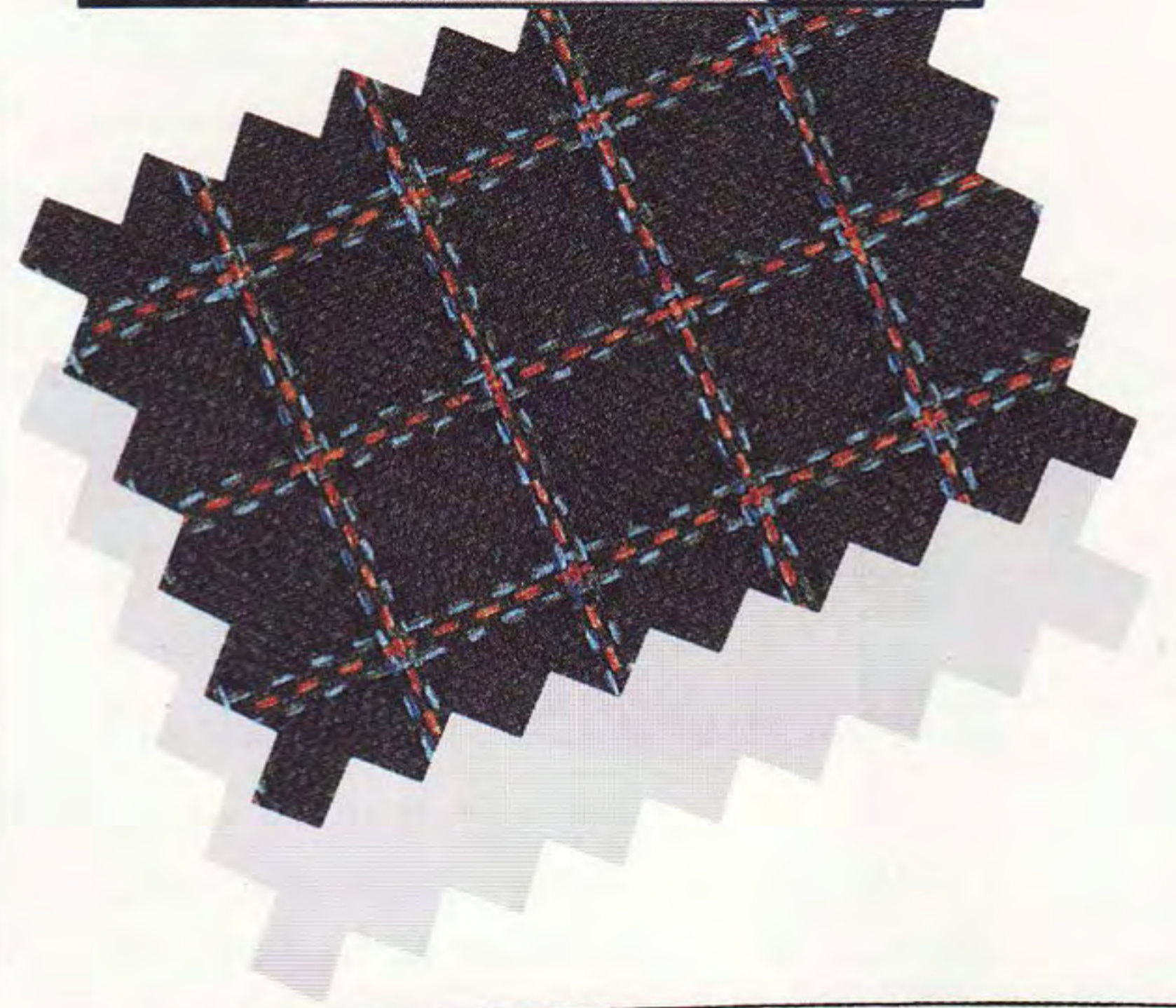
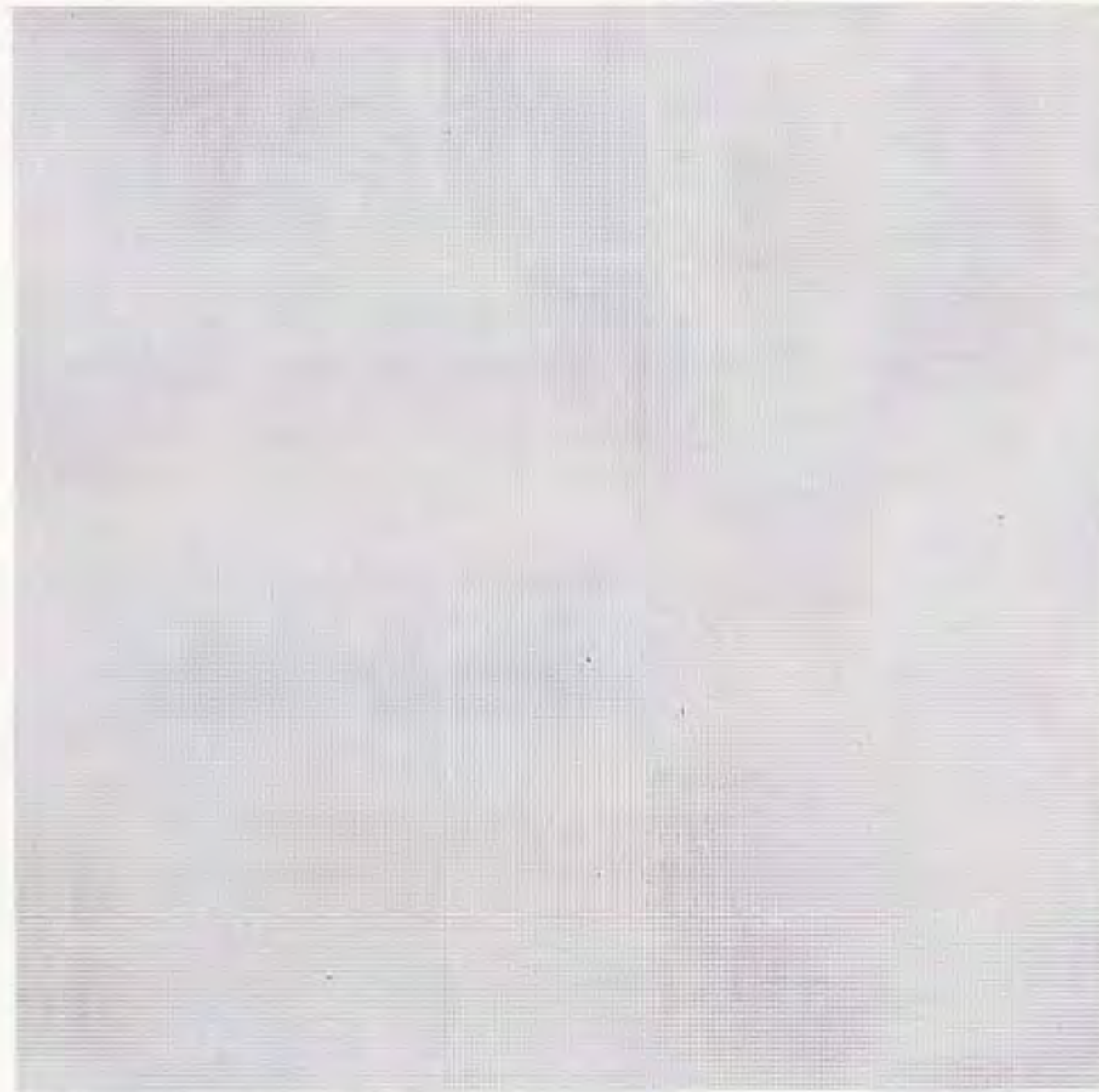
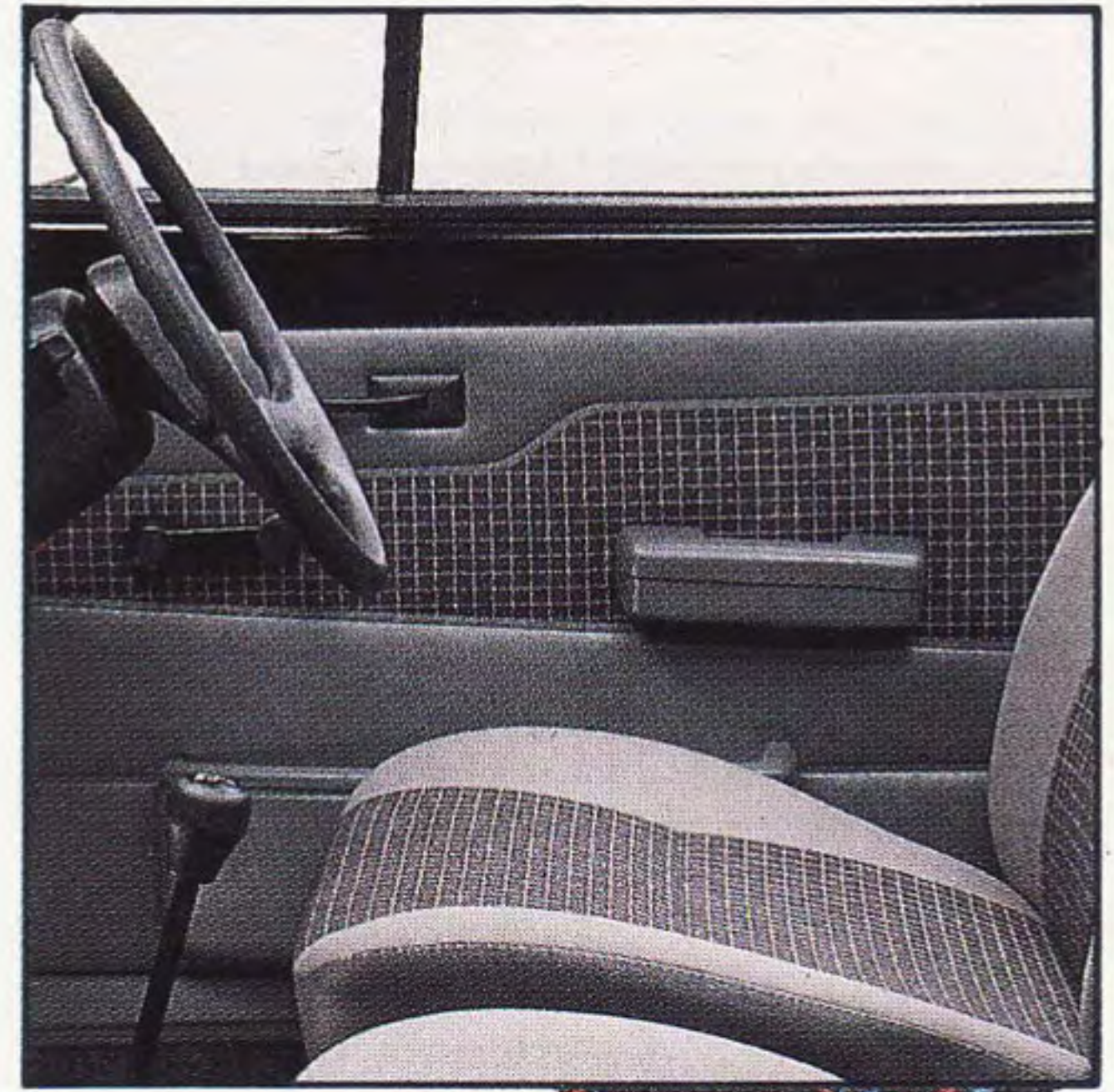

■ Full wheel covers finished in Tri-coat White are features typical of the value-for-money Fiesta Bonus.

■ An attractive tailgate badge identifies the new addition to Ford's best-selling Fiesta family.

True to its name, and in keeping with Ford's reputation, the new Fiesta Bonus offers outstanding value for money.

This price-is-right addition to Britain's best-selling range of smart small cars provides an unbeatable combination of style, versatility, comfort and low running costs. Take your pick from fashionable Black or metallic Strato Silver paintwork, complemented by equally attractive full wheel covers finished in Tri-coat White.



Other standard features typical of the good value Fiesta Bonus include powerful halogen headlights, reversing lights, a laminated windscreen, doors complete with stowage bins, and a remarkably efficient 950 engine designed to run on cost-cutting two-star petrol.

The smart looking car at a smart bonus price

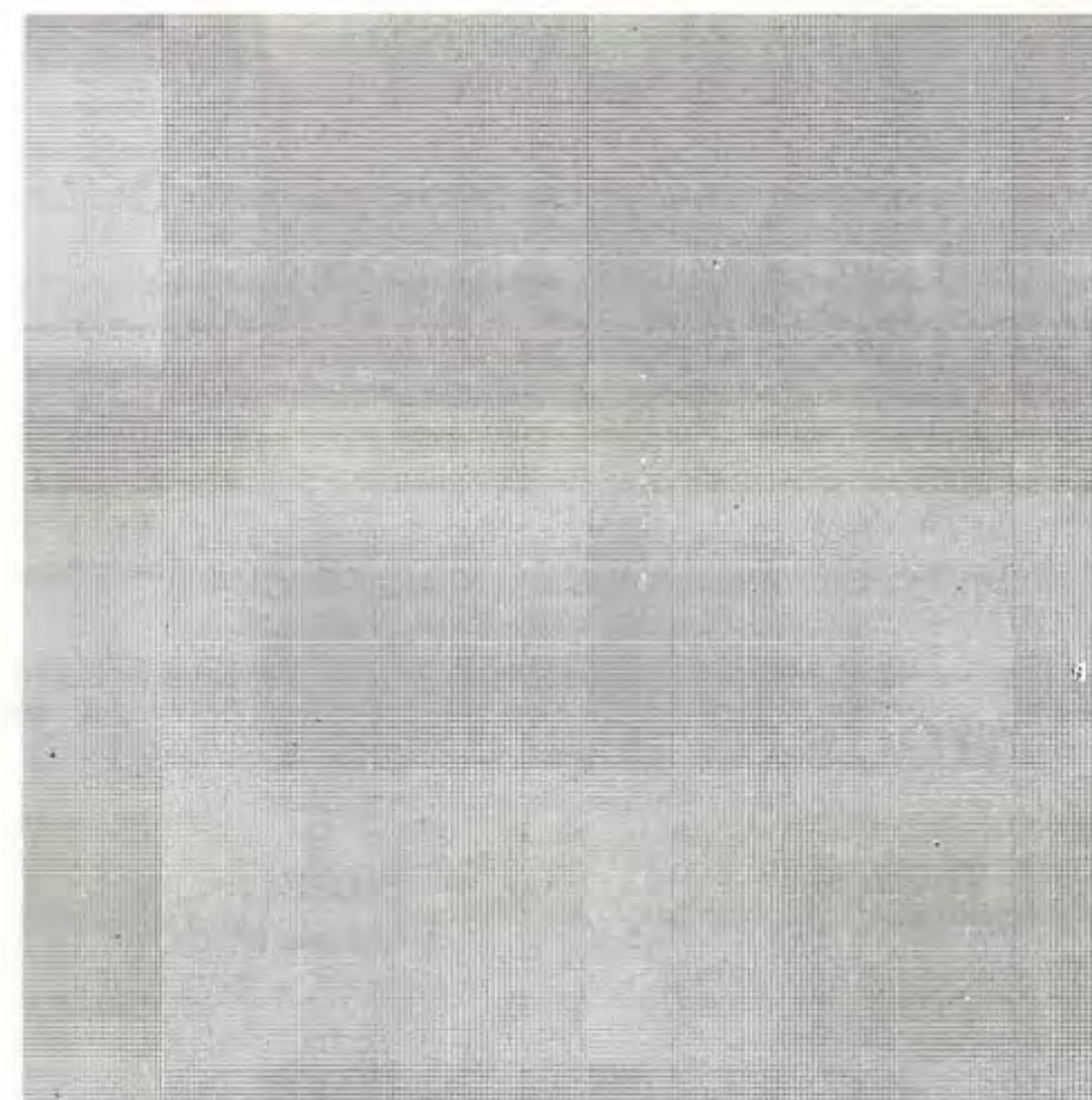

Cloth-trimmed seats, convenient controls and light, precise steering make the Fiesta Bonus an easy and enjoyable car to drive. It nips through town traffic, and is a strong performer on the open road.

Luggage? Space is increased from 7.6 to 31.8 cubic feet* by lowering the rear seatback.



■ Ford's stylish new Fiesta is available with Black or Strato Silver paintwork. Like all Ford cars, it is protected by a six-year corrosion assurance.

*Loadspace capacities measured using the VDA method.

Fiesta Bonus Features

ENGINEERING

- Body, three-door saloon
- 950 OHV engine with four-speed gearbox
- Manual choke, Electronic breakerless ignition
- 135 x 13 tyres with 5 x 13 wheels

EXTERIOR

- 'Bonus' decal on tailgate
- Full wheelcovers in tri-coat white
- Body colour steel bumpers with protective inserts and grey end caps
- Single tone horn

INTERIOR

- Klee patterned cloth
- Grey fleece passenger compartment carpet
- Grey fleece carpet luggage compartment floor
- Door trim moulded panel including soft feel armrest, grab handles, stowage bins and door pulls
- Perforated neutral tone headlining
- Passenger lower stowage shelf
- Concealed stowage compartment under rear loadspace

- Anti-dazzle rear view mirror
- Two spoke steering wheel
- Flick wipe wipers

EXTERIOR BODY COLOURS

The Fiesta Bonus is available in two colours only — Black or Strato Silver. These are normally at extra cost on the Fiesta.

Extra Cover Plans available, see your Ford Dealer for details



Standard features on all Fiesta models

- **Ashtrays:** One mounted in instrument panel centre stack One rear
- **Controls:** Three steering column stalks controlling light functions, front wash/wipe functions, indicators and horn
- **Heater/ventilation:** Illuminated heater controls Three-speed illuminated heater blower switch Two face level vents, air temperature direction and flow controlled
- **Instruments:** Speedometer, odometer, fuel gauge, water temperature gauge, warning lights for oil pressure, direction indicators, high beam, ignition/alternator brake failure, 'lights-on'
- **Instrument panel:** Black instrument binnacle Driver's side lower stowage
- **Lights:** Front courtesy light, header mounted operated by switches on front doors
- **Seats:** Fully reclining front Folding rear seat back
- **Seat belts:** Front inertia reel Rear outboard inertia reel and centre lap static
- **Sunvisors, two swivelling**
- **Switches:** Illuminated instrument panel mounted auxiliary micro switch
- **Tailgate gas struts, two**
- **Wipers:** Two-speed Electric wash
- **Fuel tank cap locking by ignition key**

- **Lights:** Halogen headlamps Hazard warning flashers Rear fog lamp Reversing lamps Side repeat flashers

- **Locks:** Anti-burst door locks
- **Spoiler, front integral**

- **Tow hooks front and rear**
- **Wheels, 5 x 13 steel**

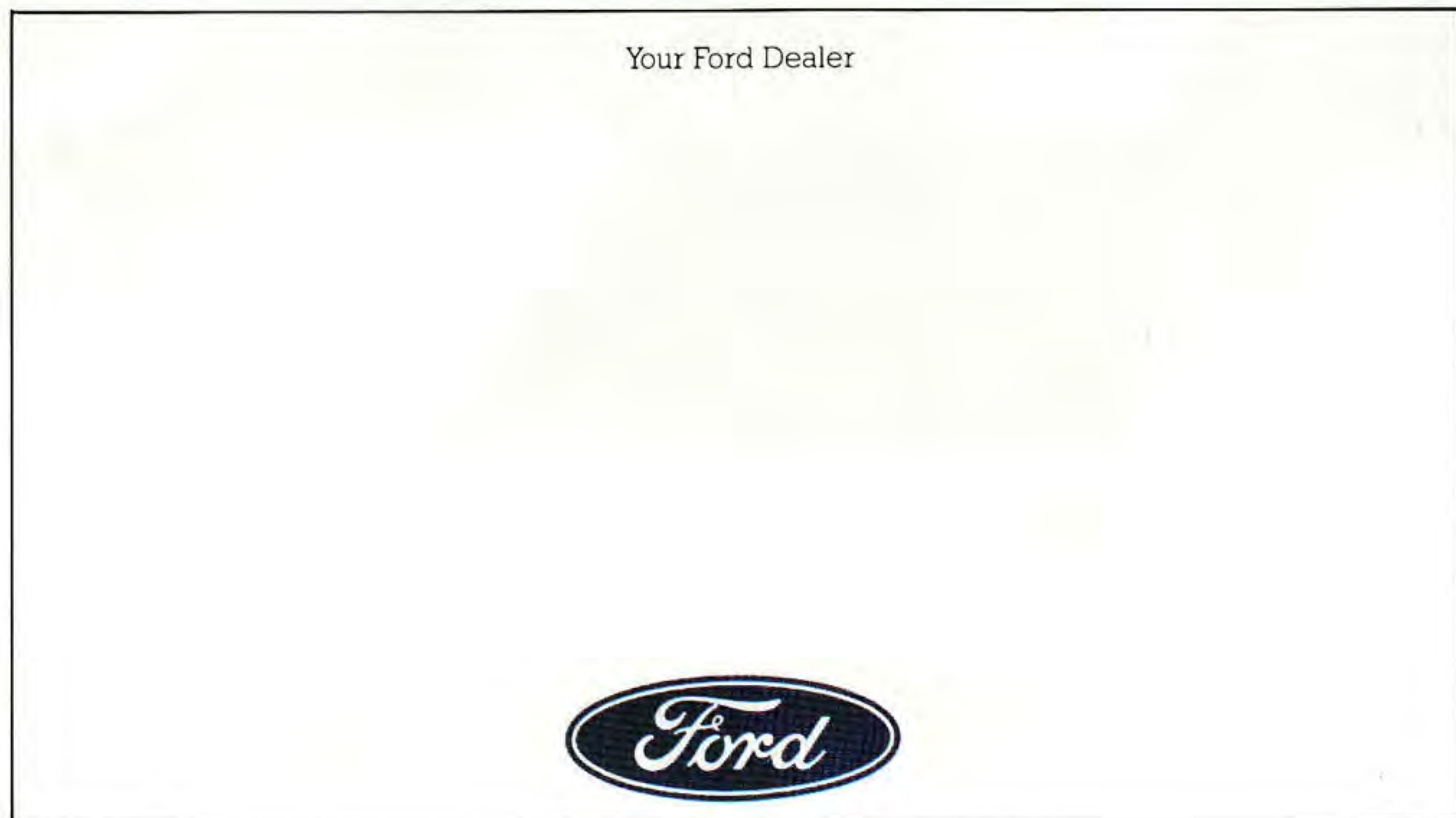
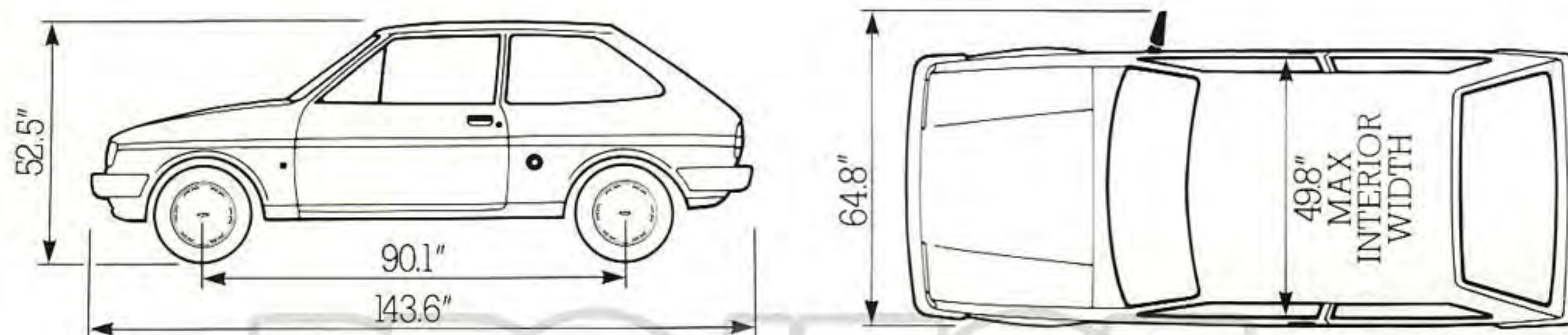

MAXIMUM RETAIL PRICE

Includes Car Tax and VAT

Fiesta Bonus 950 OHV £4299.00

Options at extra cost:
 Tailgate wash/wipe £ 124.49
 Heated rear window £ 99.69

PRICES. VAT shown in this leaflet is calculated at 15%. The total price of a car, including Car Tax, options and accessories fitted by the Ford Dealer, will be subject to VAT on retail price. The prices quoted in this Guide are the maximum prices, and do not include the cost of number plates. In addition, a standard delivery charge of £124.52 plus £18.68 VAT total £143.20 will be made on all models. (A further charge will be made on vehicles to the Channel Islands and the Isle of Wight.)

ILLUSTRATIONS, DESCRIPTIONS AND SPECIFICATIONS

Ford policy is one of continuous product development. The right is reserved to change specifications, colours and prices of the models and items illustrated and described in this publication at any time. Where possible, any such changes which may be introduced after publication of this booklet but before it is supplied will be incorporated herein or announced by means of a notice prominently displayed in Ford Dealerships at the point of supply. For the latest details always consult your Ford Dealer.

Published by
 Car and Truck Marketing
 Programmes,
 Ford Motor Company Limited,
 Brentwood, Essex, England.
 FA 811
 July 1987

Designed and produced by
 Allan Burrows Limited
 Ingatestone, Essex.

Printed in England by
 Jarrold & Sons Limited
 Norwich.